

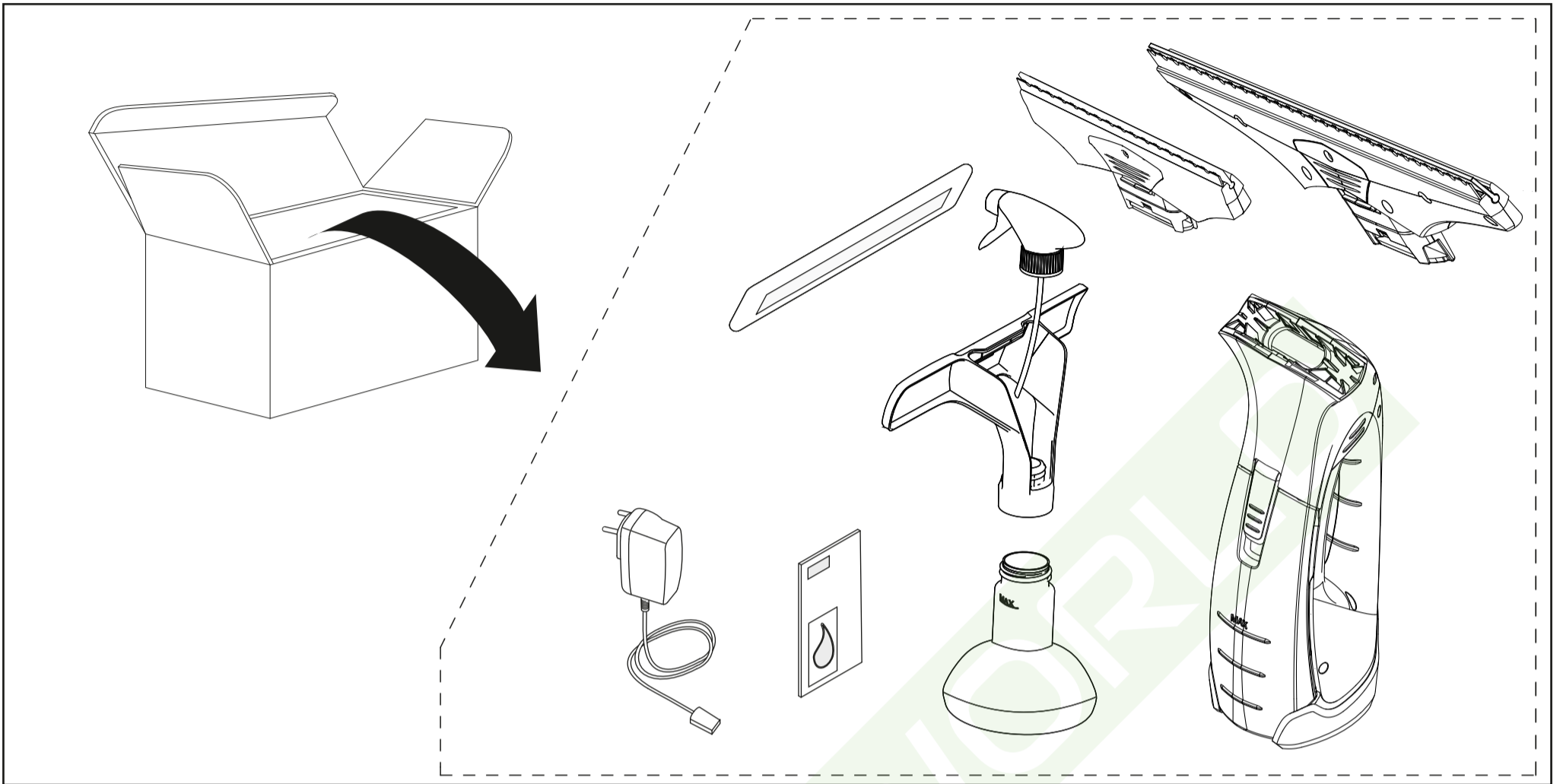

WV 2 Black Edition

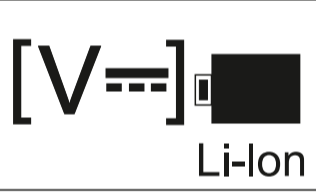

 Li-Ion	3,7 V		IPX4		0,6 kg
 nom	10 W		100 ml		185 min
	5,5 V 600 mA		50 db(A)		35 min

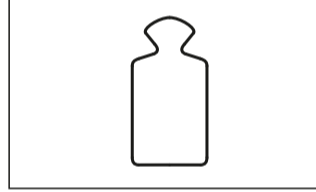
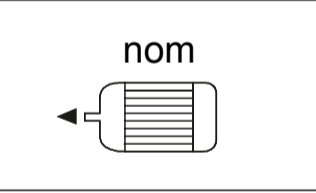
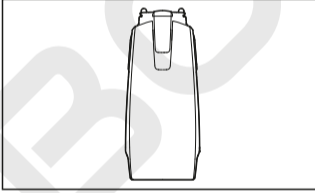
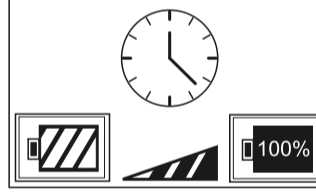
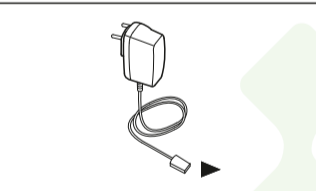
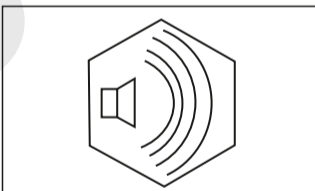
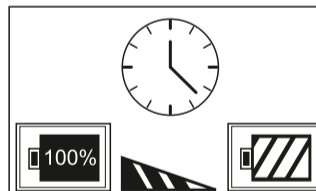